

# TREMRON®

WE MAKE IT EASY

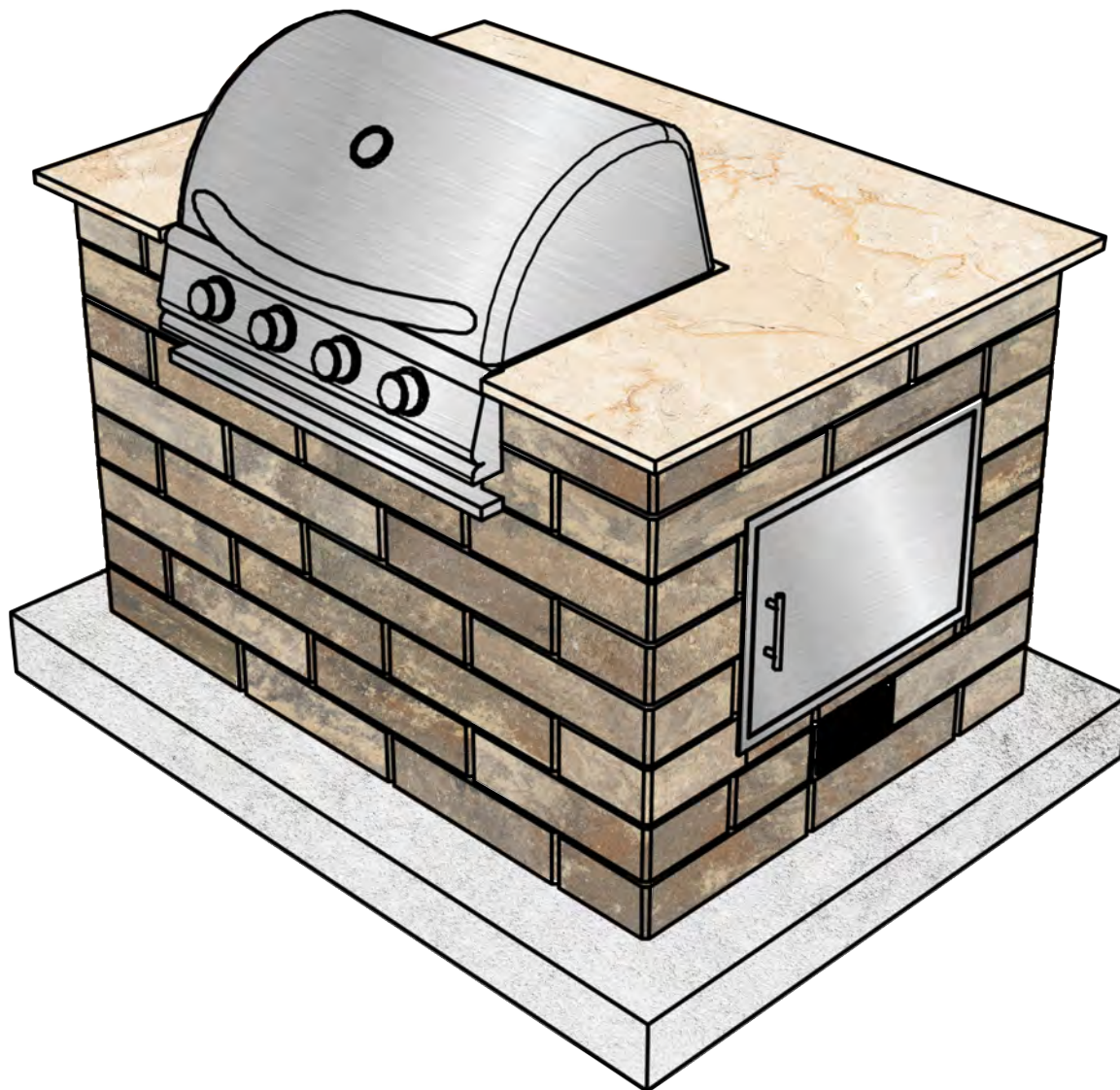

A QUIKRETE® COMPANY



**OUTDOOR LIVING DESIGNS**

## LENZA

45 X 63 GRILL TOP - RIGHT DOOR DESIGN

# LENZA - 45 x 63 GRILL TOP - RIGHT DOOR DESIGN

# OUTDOOR LIVING DESIGNS

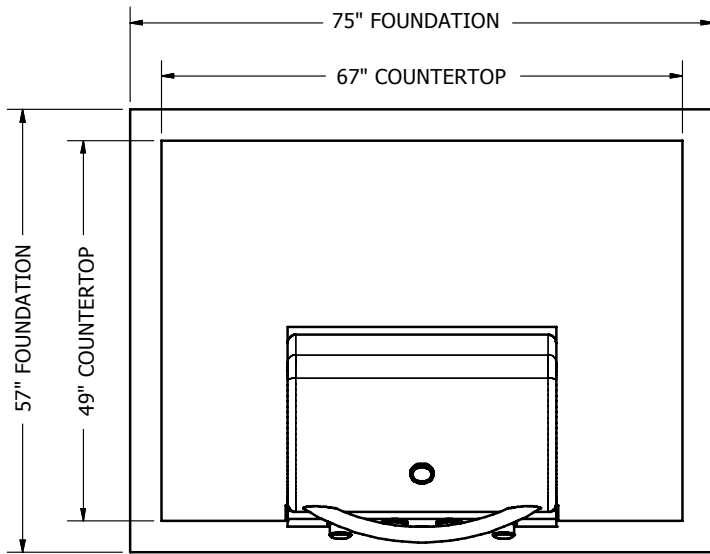

**PLAN VIEW**

**NOTE:**

1. WALL UNITS TO BE INSTALLED WITH CHANNEL ON THE BOTTOM SIDE IN ORDER TO GET THE PROPER CONTEMPORARY ESTHETIC LOOK. (WALL PRODUCT TO BE INVERTED 180 DEGREES FROM FINISHED PALLET WHEN INSTALLED).
2. SECURE EACH UNIT USING APPROVED ADHESIVE OR BONDING AGENT FOLLOWING APPLICATION DIRECTIONS PROVIDED BY PRODUCT SUPPLIER.
3. THIS DESIGN REQUIRES CUTTING UNITS TO PROPERLY FIT THE GRILL TOP AND ACCESS DOOR.
4. BUILT-IN GRILL INSERT AND ACCESS DOOR TO BE INSTALLED PER MANUFACTURES RECOMMENDATIONS.
5. STRUCTURAL SUPPORT FOR BLOCK UNITS OVER OPENINGS NOT SHOWN FOR VISUAL PURPOSES.
6. FOR PROPER INSTALLATION OF GAS GRILL REFER TO BLAZE OUTDOOR PRODUCTS - USE & CARE GUIDE GAS GRILLS BLZ-4LBM (NG/LP).
7. ALL DIMENSIONS ARE IN INCHES.

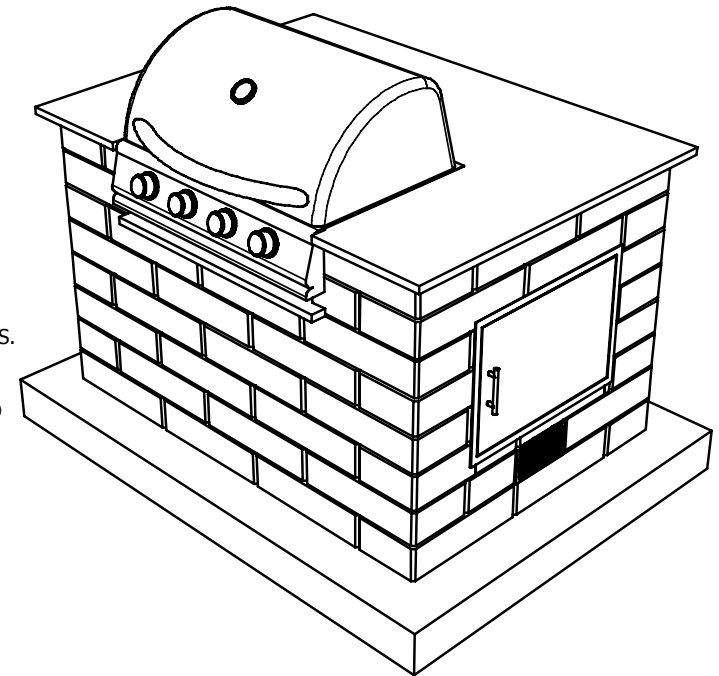

**ISOMETRIC VIEW**

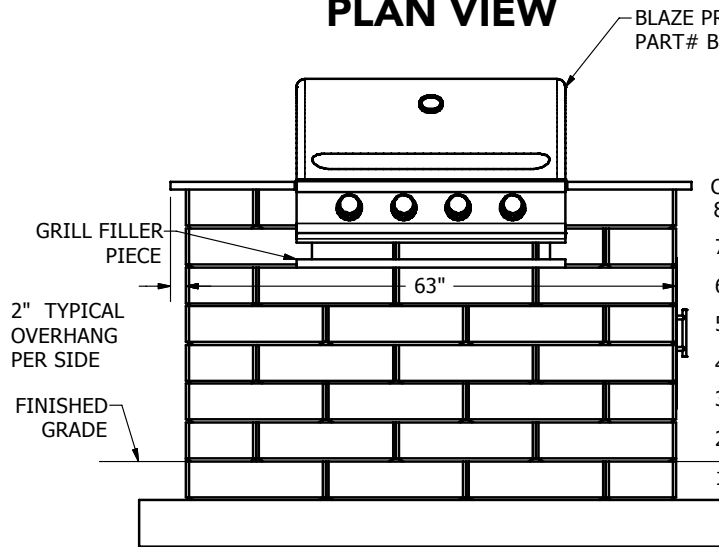

**FRONT ELEVATION VIEW**

BLAZE PRELUDE LBM 32-INCH 4-BURNER GRILL  
PART# BLZ-4LBM-LP/NG

- COUNTERTOP COURSE
- 8th COURSE WALL
- 7th COURSE WALL
- 6th COURSE WALL
- 5th COURSE WALL
- 4th COURSE WALL
- 3rd COURSE WALL
- 2nd COURSE WALL
- 1st COURSE WALL

FINISHED GRADE

FOUNDATION LEVELING PAD

6" FOUNDATION

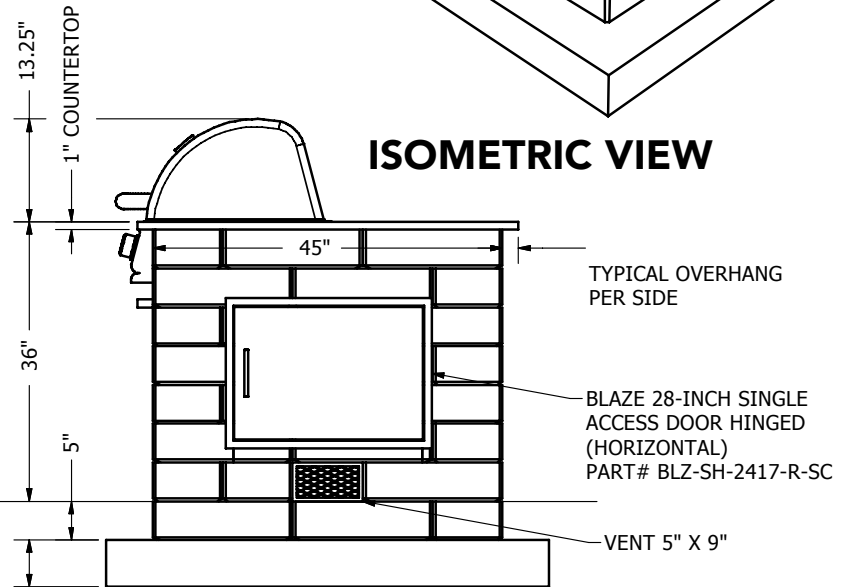

**SIDE ELEVATION VIEW**

TYPICAL OVERHANG  
PER SIDE

BLAZE 28-INCH SINGLE  
ACCESS DOOR HINGED  
(HORIZONTAL)  
PART# BLZ-SH-2417-R-SC

VENT 5" X 9"

PRODUCT COUNTS:  
(80) TOTAL WALL UNITS

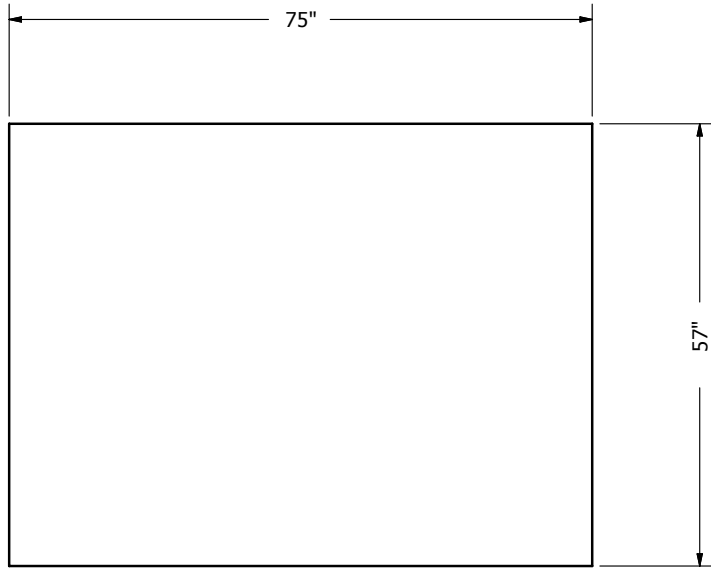

**PLAN VIEW**

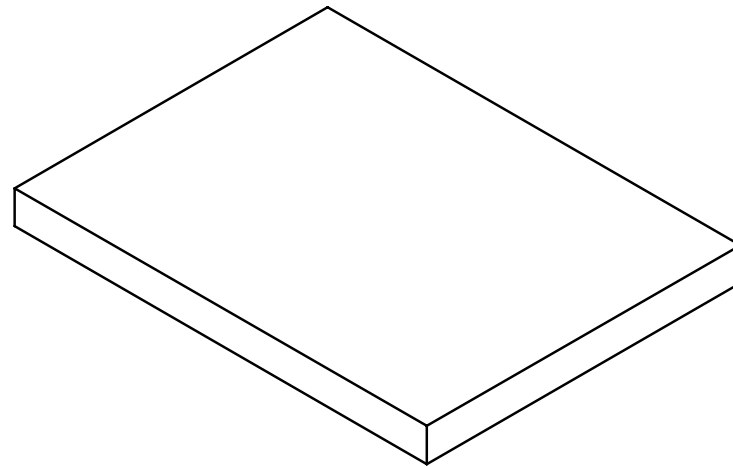

**ISOMETRIC VIEW**

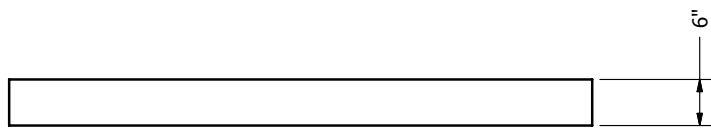

**FRONT ELEVATION VIEW**

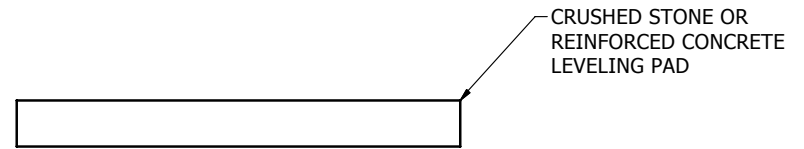

**SIDE ELEVATION VIEW**

**LENZA - 45 x 63 GRILL TOP - RIGHT DOOR CUT DESIGN - FOUNDATION LEVELING PAD**

NOTE:  
1. WALL UNITS TO BE INSTALLED WITH CHANNEL ON THE BOTTOM SIDE  
(PRODUCT IS TO BE INVERTED 180 DEGREES FROM FINISHED PALLET).

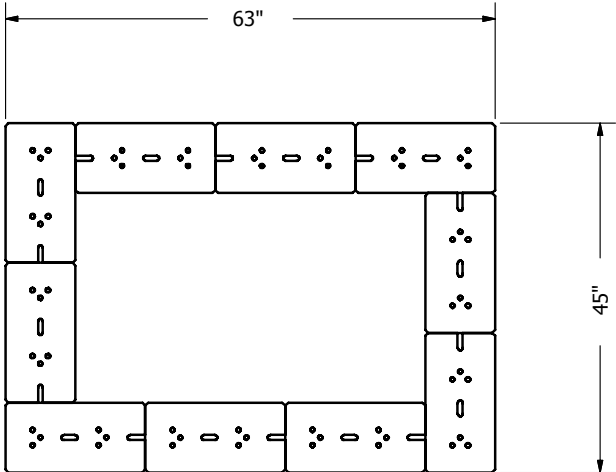

**PLAN VIEW**

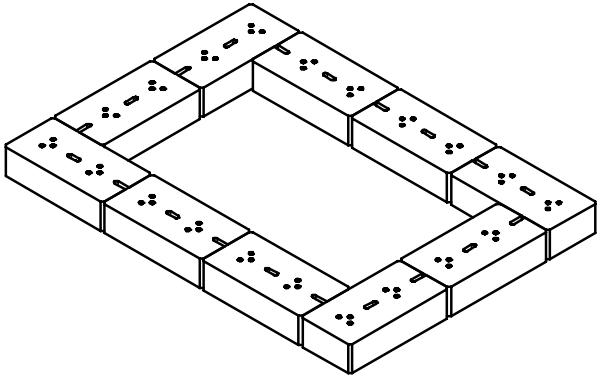

**ISOMETRIC VIEW**



**ELEVATION VIEW**



**SIDE ELEVATION VIEW**

PRODUCT COUNTS:  
(10) TOTAL WALL UNITS

**LENZA - 45 x 63 GRILL TOP - RIGHT DOOR CUT DESIGN - 1st COURSE**

**LENZA - 45 x 63 GRILL TOP - RIGHT DOOR DESIGN**

**OUTDOOR LIVING DESIGNS**

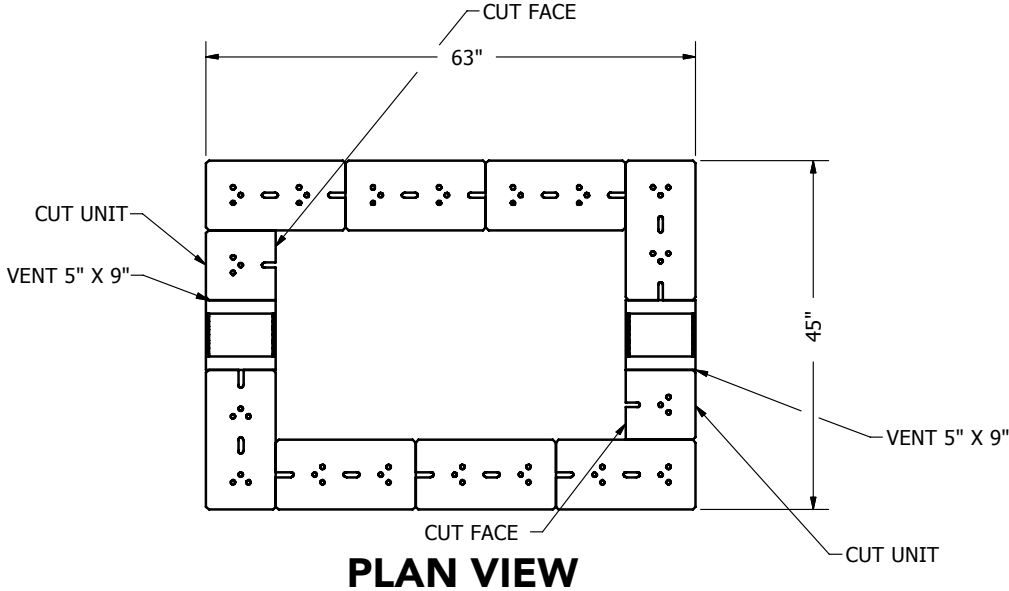

NOTE:  
 1. WALL UNITS TO BE INSTALLED WITH CHANNEL ON THE BOTTOM SIDE  
 (PRODUCT IS TO BE INVERTED 180 DEGREES FROM FINISHED PALLET).

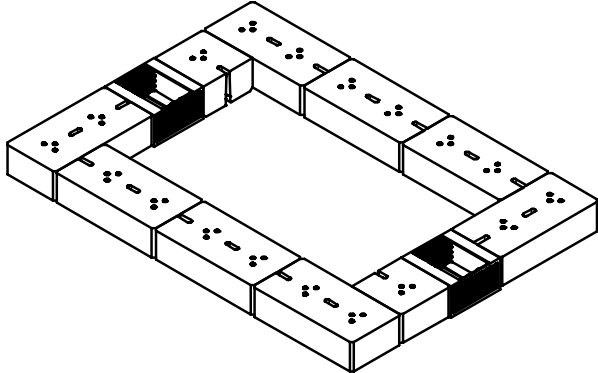

**ISOMETRIC VIEW**



**FRONT ELEVATION VIEW**



**SIDE ELEVATION VIEW**

**LENZA - 45 x 63 GRILL TOP - RIGHT DOOR CUT DESIGN - 2nd COURSE**

PRODUCT COUNTS:  
 (10) TOTAL WALL UNITS

# LENZA - 45 x 63 GRILL TOP - RIGHT DOOR DESIGN

# OUTDOOR LIVING DESIGNS

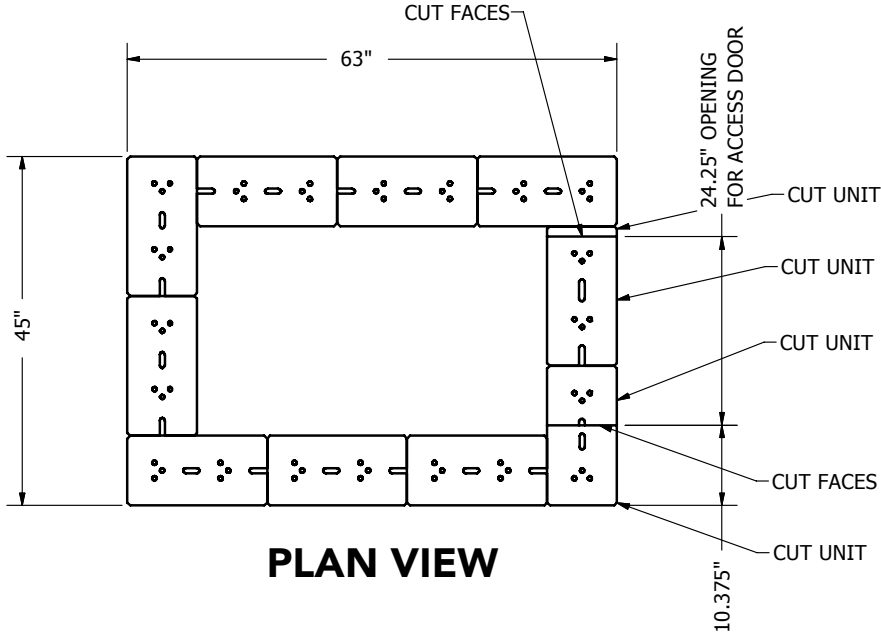

**PLAN VIEW**

NOTE:  
 1. WALL UNITS TO BE INSTALLED WITH CHANNEL ON THE BOTTOM SIDE  
 (PRODUCT IS TO BE INVERTED 180 DEGREES FROM FINISHED PALLET).

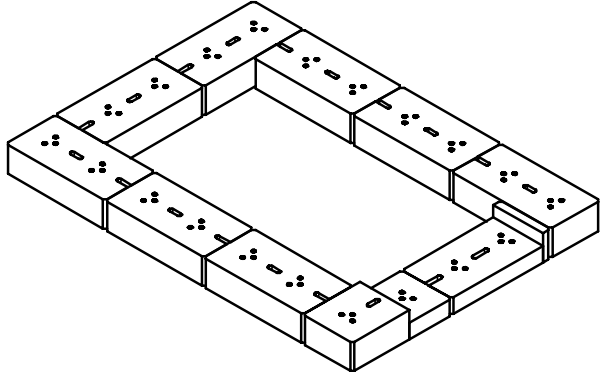

**ISOMETRIC VIEW**



**FRONT ELEVATION VIEW**

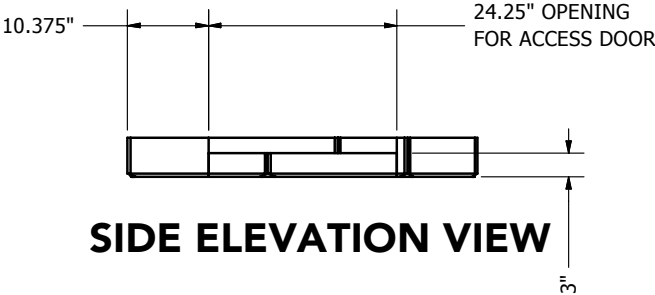

**SIDE ELEVATION VIEW**

PRODUCT COUNTS:  
 (12) TOTAL WALL UNITS

## LENZA - 45 x 63 GRILL TOP - RIGHT DOOR CUT DESIGN - 3rd COURSE

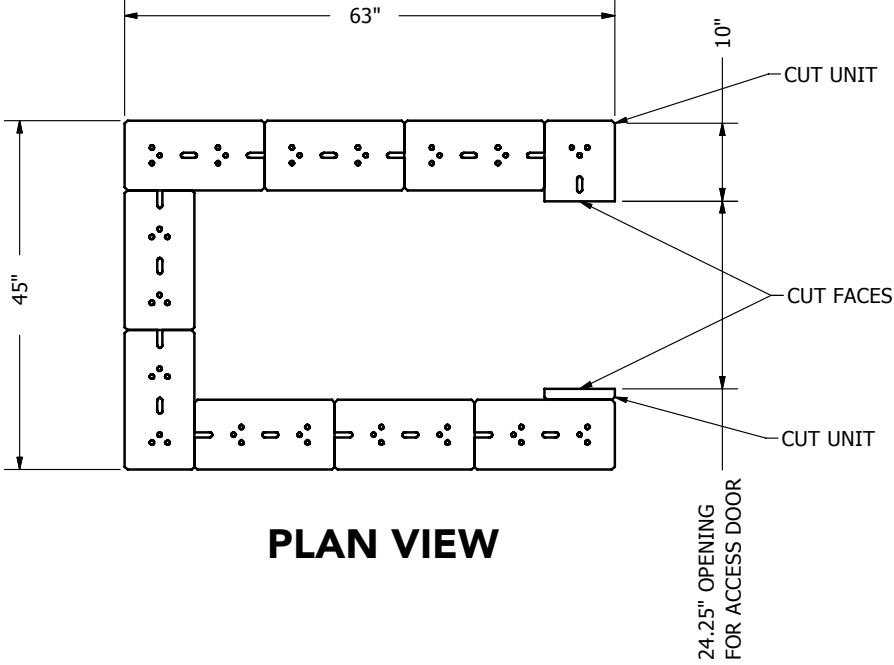

**PLAN VIEW**

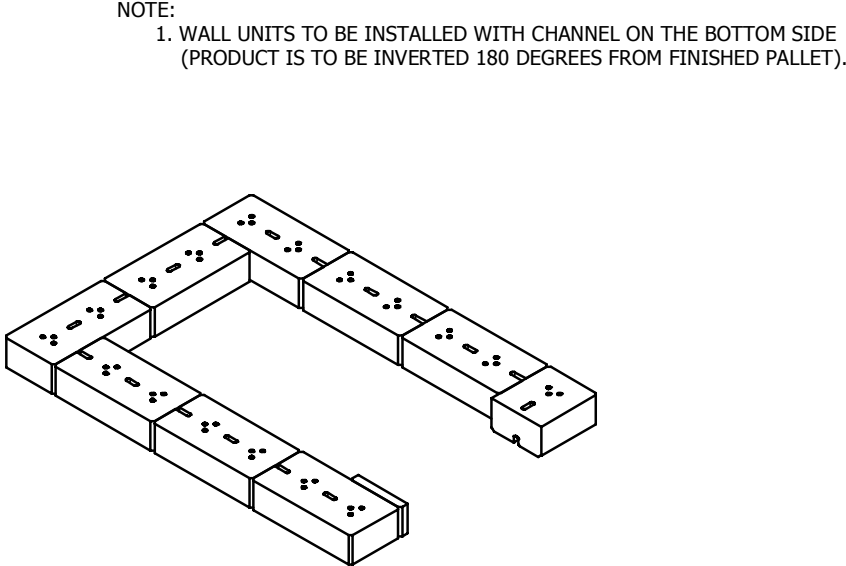

**ISOMETRIC VIEW**

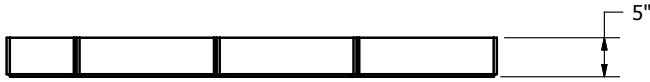

**FRONT ELEVATION VIEW**



**SIDE ELEVATION VIEW**

PRODUCT COUNTS:  
(10) TOTAL CAP UNITS

**LENZA - 45 x 63 GRILL TOP - RIGHT DOOR CUT DESIGN - 4th AND 6th COURSES**

**LENZA - 45 x 63 GRILL TOP - RIGHT DOOR DESIGN**

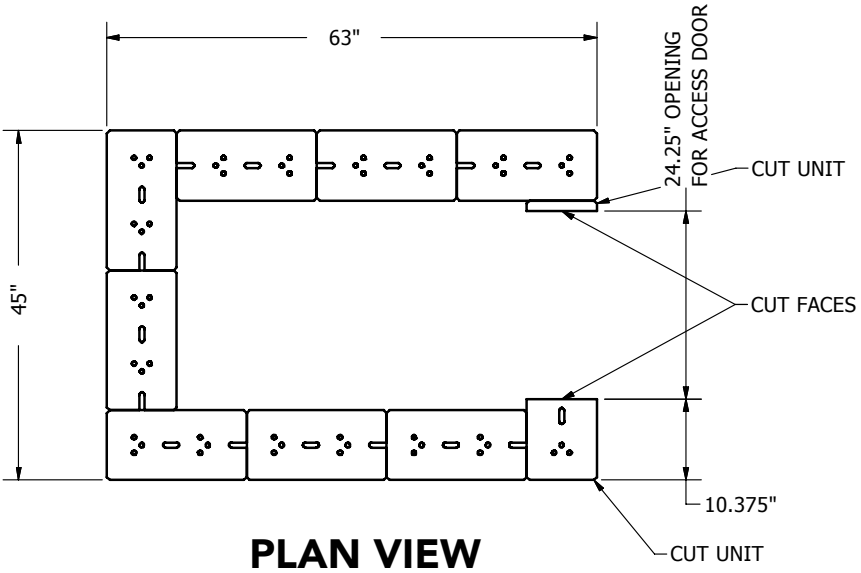

NOTE:  
 1. WALL UNITS TO BE INSTALLED WITH CHANNEL ON THE BOTTOM SIDE (PRODUCT IS TO BE INVERTED 180 DEGREES FROM FINISHED PALLET).

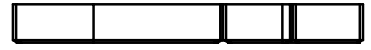
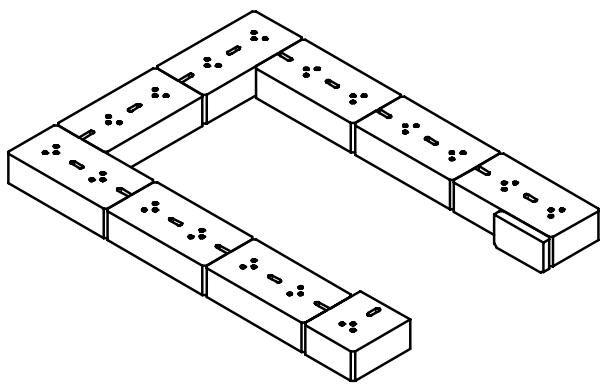

PRODUCT COUNTS:  
 (10) TOTAL CAP UNITS

**LENZA - 45 x 63 GRILL TOP - RIGHT DOOR CUT DESIGN - 7th COURSE**

**LENZA - 45 x 63 GRILL TOP - RIGHT DOOR DESIGN**

**OUTDOOR LIVING DESIGNS**

- NOTE:
1. WALL UNITS TO BE INSTALLED WITH CHANNEL ON THE BOTTOM SIDE (PRODUCT IS TO BE INVERTED 180 DEGREES FROM FINISHED PALLET).
  2. GRILL FILLER PIECE IS TO BE MADE FROM THE SAME MATERIAL AS THE COUNTER TOP, (1" ± THICK).
  3. UNLESS OTHERWISE DIRECTED INSTALL AND SECURE GRILL FILLER PIECE WITH APPROVED ADHESIVE OR BONDING AGENT.

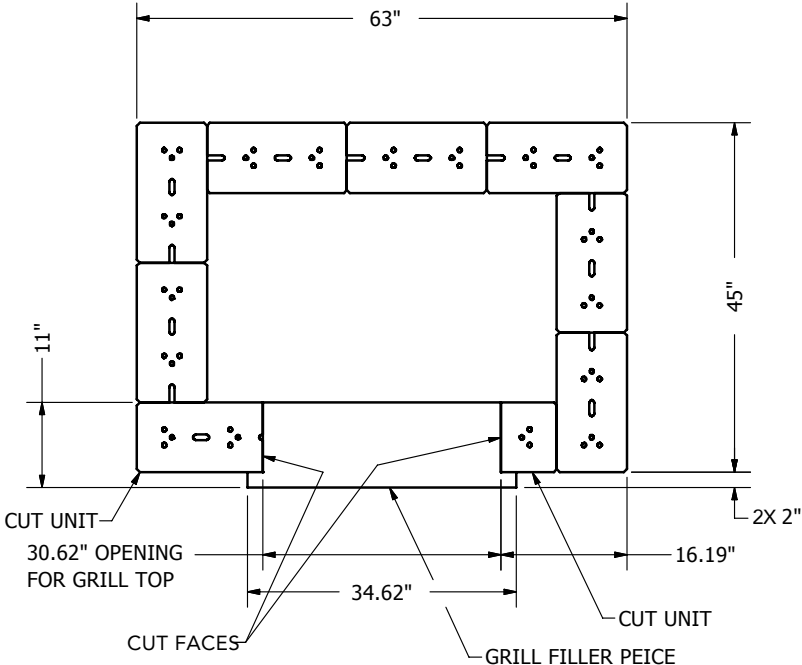

**PLAN VIEW**

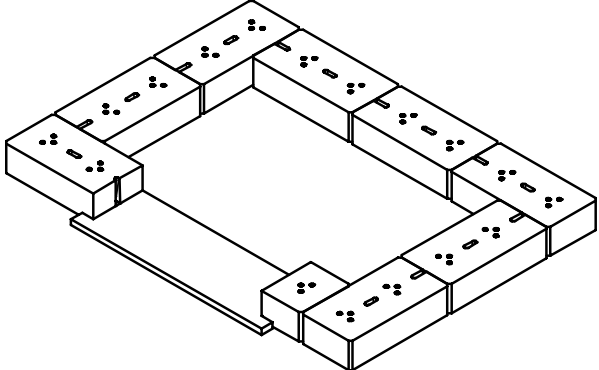

**ISOMETRIC VIEW**

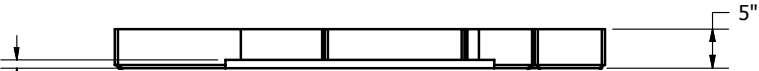

**FRONT ELEVATION VIEW**



**SIDE ELEVATION VIEW**

**LENZA - 45 x 63 GRILL TOP - RIGHT DOOR CUT DESIGN - 8th COURSE**

PRODUCT COUNTS:  
(9) TOTAL WALL UNITS

NOTE:  
1. WALL UNITS TO BE INSTALLED WITH CHANNEL ON THE BOTTOM SIDE  
(PRODUCT IS TO BE INVERTED 180 DEGREES FROM FINISHED PALLET).

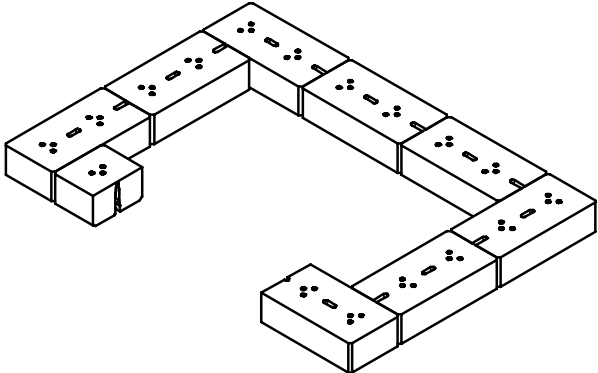
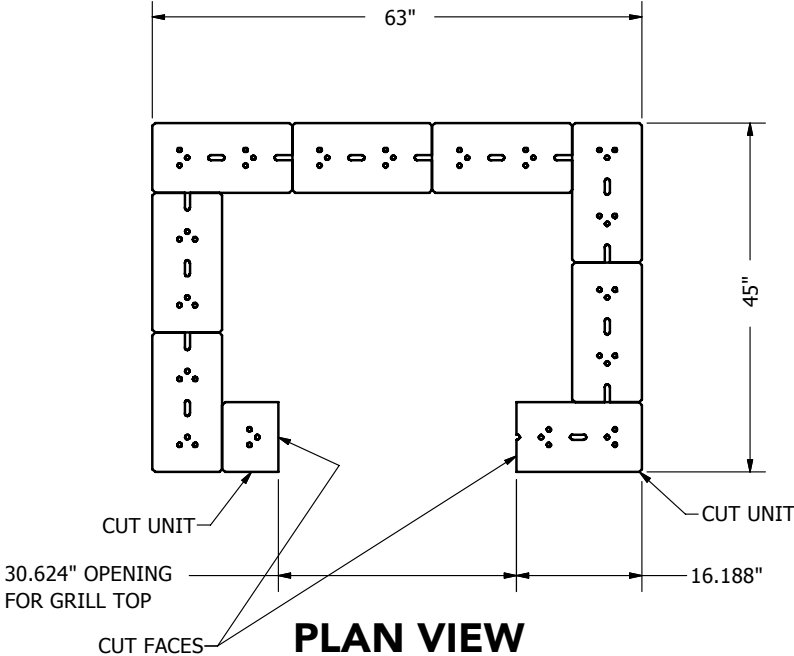

**ISOMETRIC VIEW**



**FRONT ELEVATION VIEW**



**SIDE ELEVATION VIEW**

PRODUCT COUNTS:  
(9) TOTAL WALL UNITS

**LENZA - 45 x 63 GRILL TOP - RIGHT DOOR CUT DESIGN - 9th COURSE**

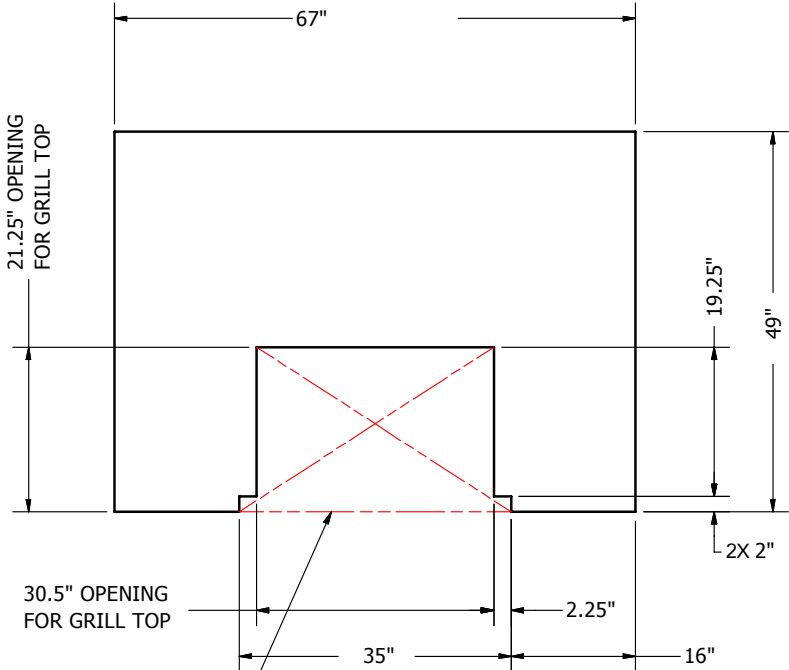

NOTE:  
1. UNLESS OTHERWISE DIRECTED INSTALL AND SECURE COUNTERTOP WITH APPROVED ADHESIVE OR BONDING AGENT.

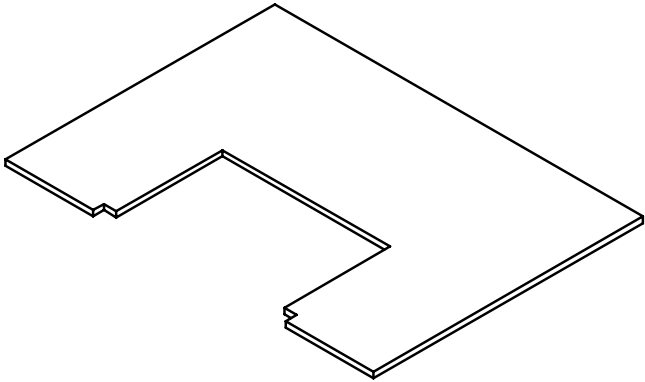

**ISOMETRIC VIEW**

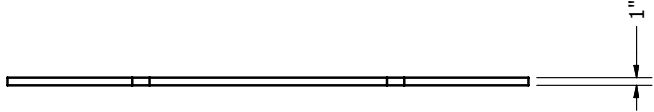

**FRONT ELEVATION VIEW**



**SIDE ELEVATION VIEW**

**LENZA - 45 x 63 GRILL TOP - RIGHT DOOR CUT DESIGN - COUNTERTOP COURSE**