



Note: Image shown does not exactly match the detail within this design.

*Stonegate*



## GRILL STATION INSTALLATION INSTRUCTIONS



# KEYSTONE OUTDOOR KITCHEN - LINEAR DESIGN

## BASIC TOOLS

SAFETY		ALTERATIONS		LAYOUT		FINISHING		LEVELING		GENERAL		
												
Gloves	Safety Glasses	Stone Chisel	Mallet	Layout Stakes	Line	Caulking Gun	Concrete Adhesive	Level	Mallet	Shovel	Wheelbarrow	Hand Compactor

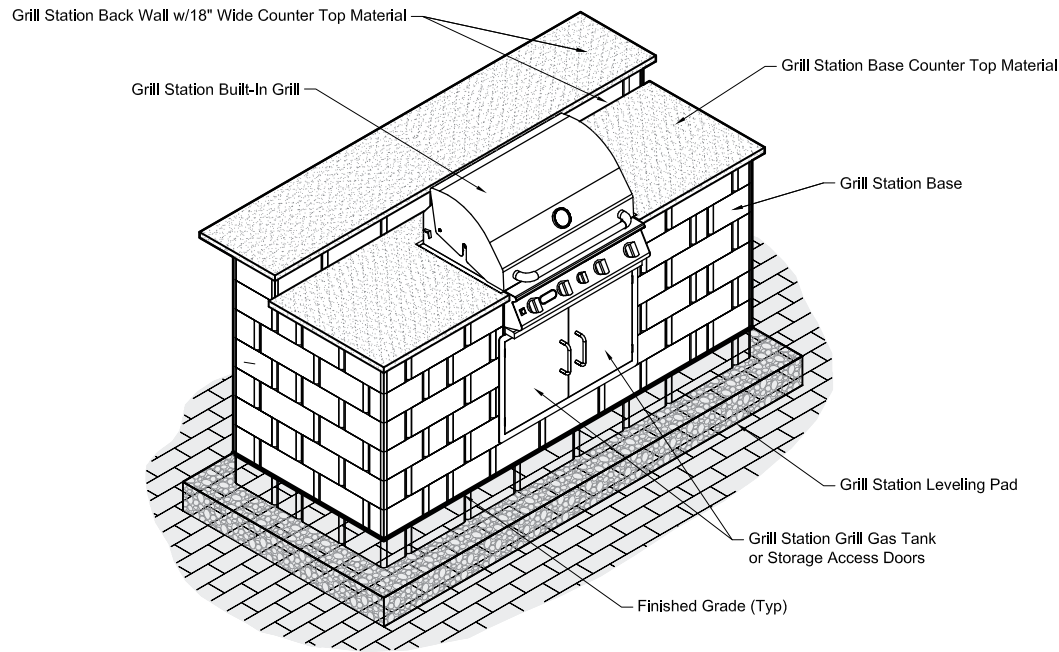

Grill Station Kit Front Isometric

### You will need:

- 55 - 16"/14"w Country Manor/Stonegate Large units
- 57 - 12"/10"w Country Manor/Stonegate Medium units
- 57 - 6"/4"w Country Manor/Stonegate Small units
- Leveling Pad Material - 17 cf
- 200 ± Keystone Interlocking Pins\* (50/bag)
- 4 Tubes ± Exterior Grade Construction Adhesive
- Built-in Grill\* (30¾"w x 20" d x 9⅞"h rough opening)
- Access Door\* (15¾"w x 22"h rough opening)
- Upper Counter Material - 91" x 18"
- Lower Counter Material - 91" x 27½"

\*Modify rough opening sizes in both the block units and counter top to accommodate different sized appliances, if needed.

### Notes:

- All Keystone Country Manor/Stonegate units are 6"h x 10" d.

\* Keystone recommends the use of its interlocking pins when alignment allows. Use pins in conjunction with concrete adhesive to maximize stability of your structure.

**Note:**

This design uses a Outdoor Stainless Steel Built-In Grill Insert w/Stainless Steel Accessories.

**Access Door Installation Note:**

After built-in grill is installed, adjust doors w/frame vertically to desired position. Shim frame as needed. Fill top and or bottom exposed openings w/stainless steel trim as needed.

**General Note:**

In consideration of freeze / thaw issues during the cold weather season it is recommended that this outdoor built-in grill station element be protected from rain, snow and ice as necessary.

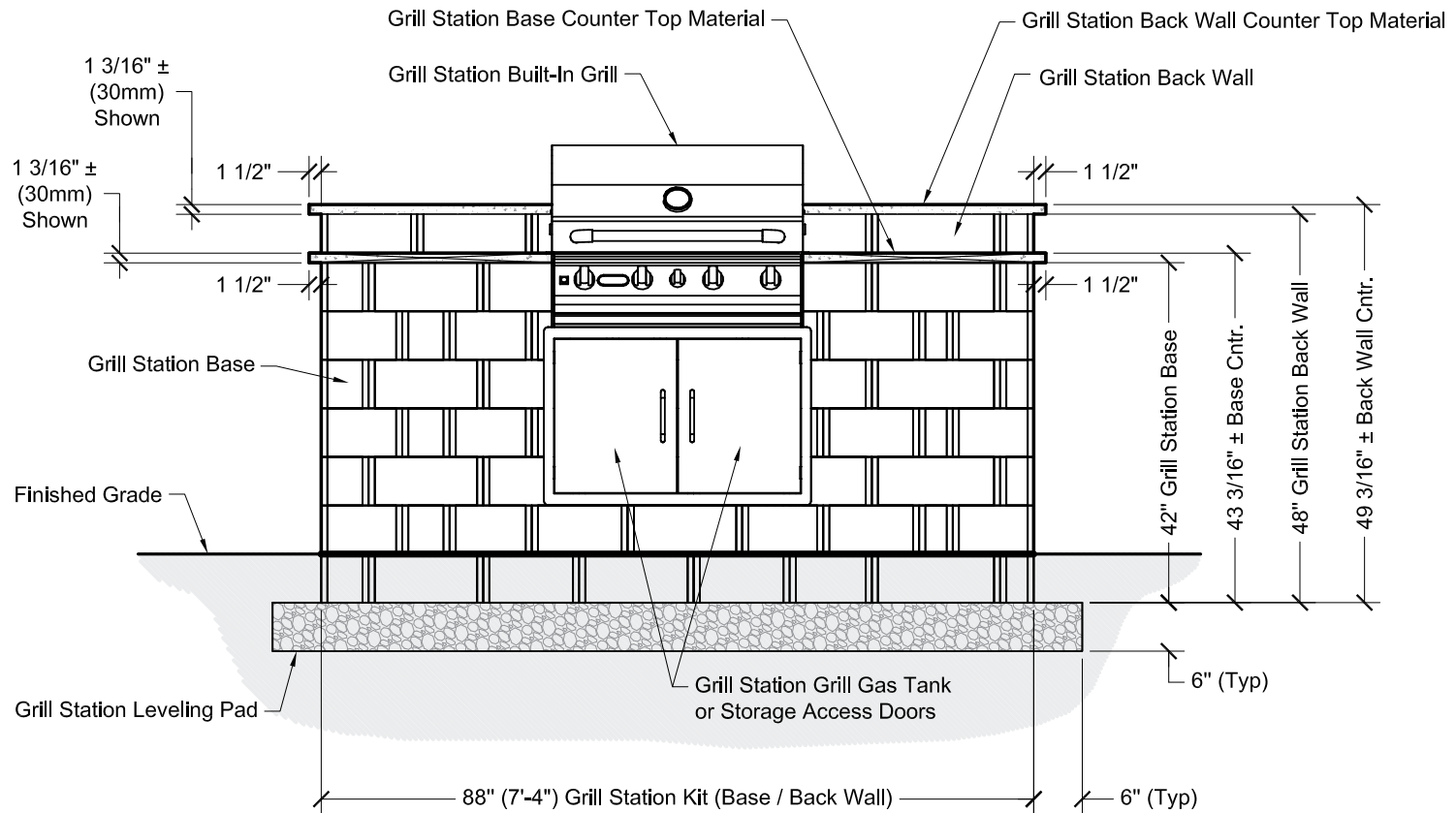

**Grill Station Kit Front Elevation**

# KEYSTONE OUTDOOR KITCHEN - LINEAR DESIGN

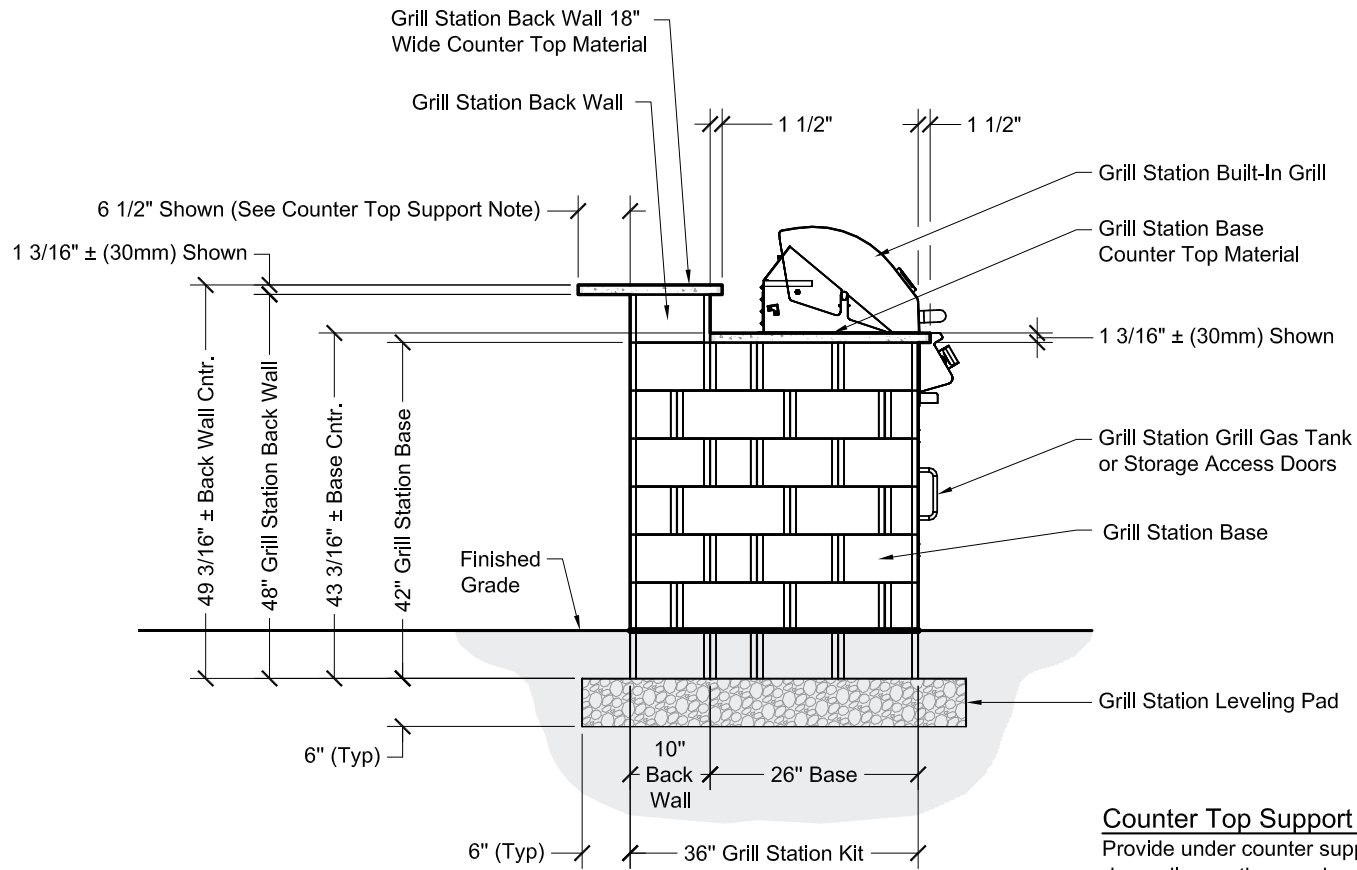

**Counter Top Support Note:**

Provide under counter support as needed depending on the over hang of the counter and the type of counter top material used.

**Grill Station Kit Side Elevation**

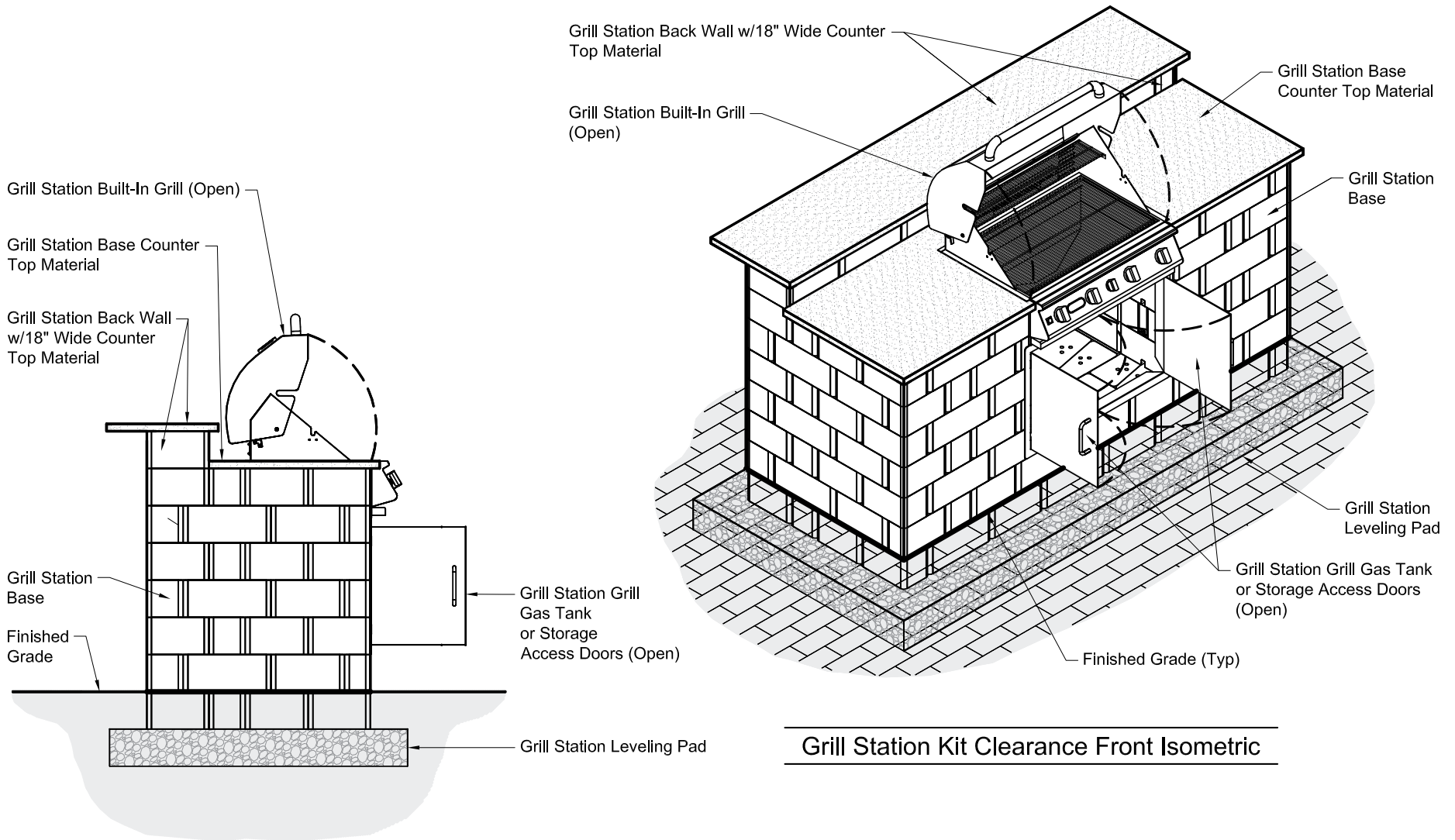

**Grill Station Kit Clearance Side Elevation**

**Grill Station Kit Clearance Front Isometric**

## Foundation Isometric

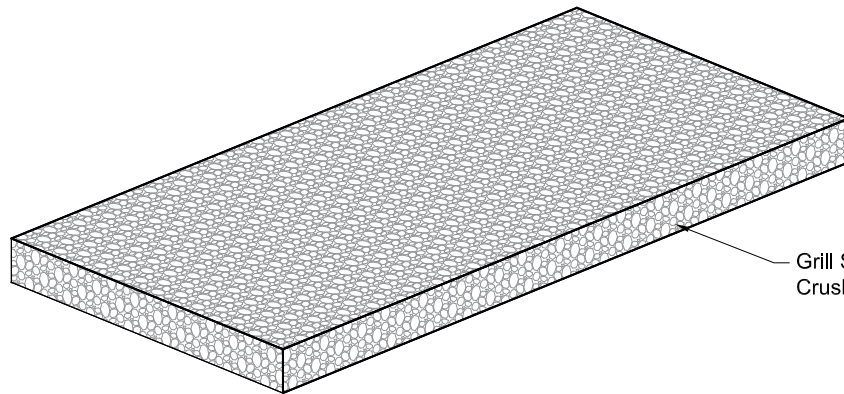

Grill Station Reinforced Concrete or  
Crushed Stone Leveling Pad

### On Grade Installation Note:

If the Grill Station is to be built on top of a stable patio or hardscape surface eliminate the 1st course and base leveling pad from the grill station design.

### Appliance Service Note:

Plan and install gas, electrical, water and drain service prior to and during construction as needed.

## Foundation Plan

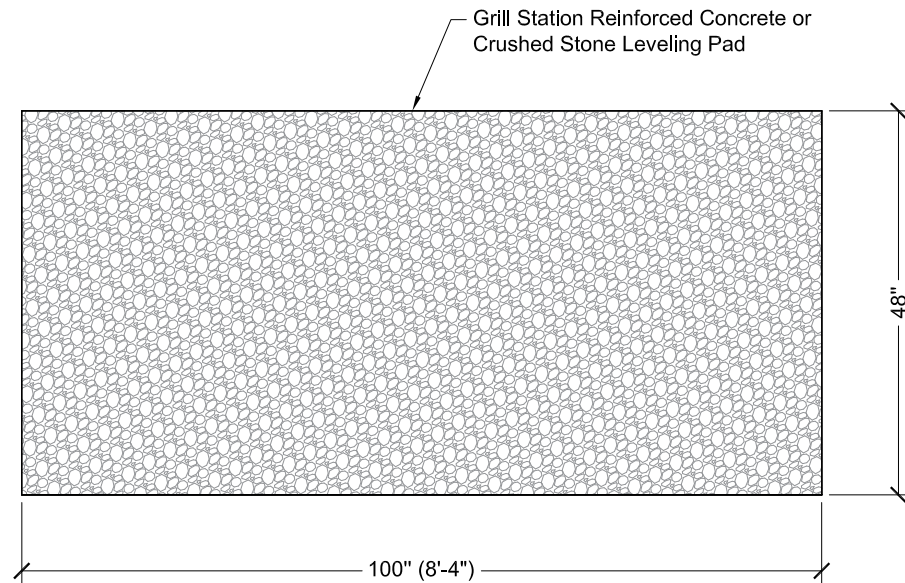

Grill Station Reinforced Concrete or  
Crushed Stone Leveling Pad

100" (8'-4")

48"

### Remember to:

- Call 811 to locate utility lines prior to digging.
- Follow manufacturer's instructions and local codes.

## 1st Course Isometric

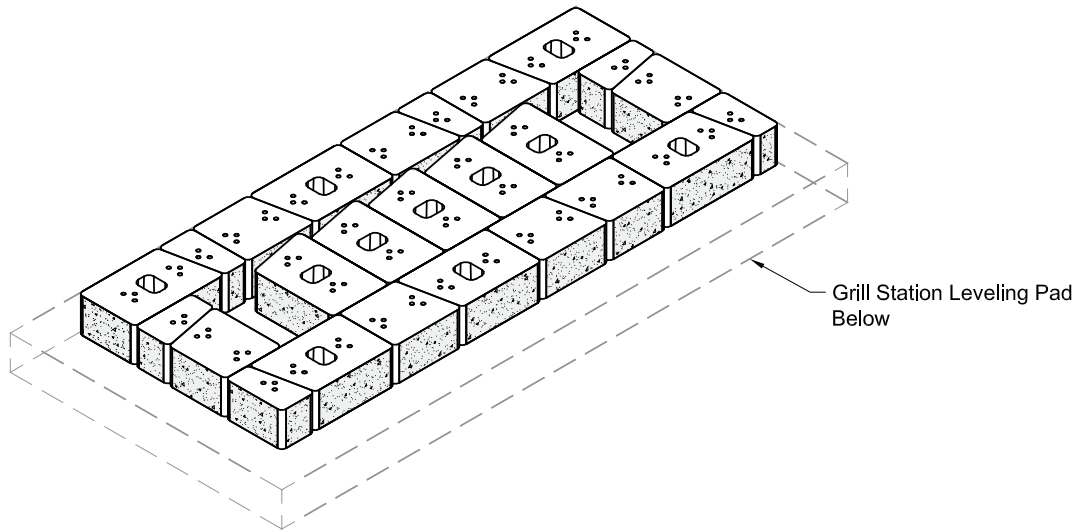

### Grill Kit Width Note:

Due to block outside face texture variances when building the grill station kit courses the outside dimensions of the courses may get wider than desired. If required cut a interior perimeter unit to get the required outside dimension.

### On Grade Installation Note:

If the Grill Station is to be built on top of a stable patio or hardscape surface eliminate the 1st course and base leveling pad from the grill station design.

## 1st Course Plan

Grill Station Leveling Pad Below

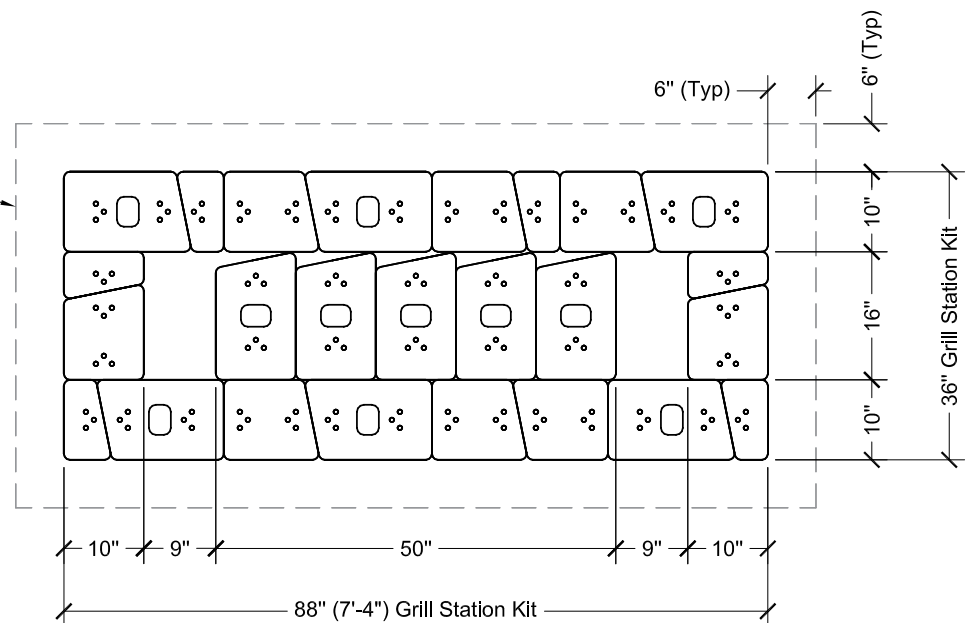

## 2nd Course Isometric

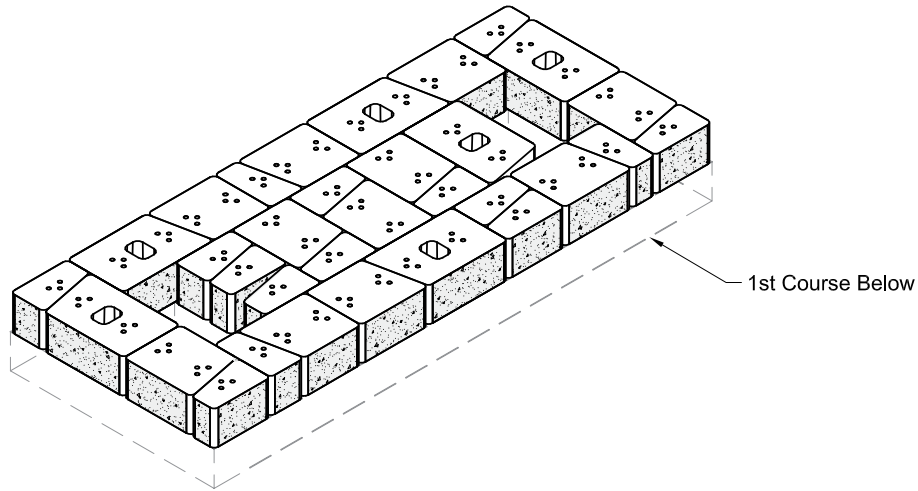

### Block Cutting Note:

Using a concrete saw or wheel grinder tool w/masonry disk, cut block units as needed. Block units to be cut due to obstruction are labeled with solid hatching. Block units to be cut to fit are labeled with angular hatching.

## 2nd Course Plan

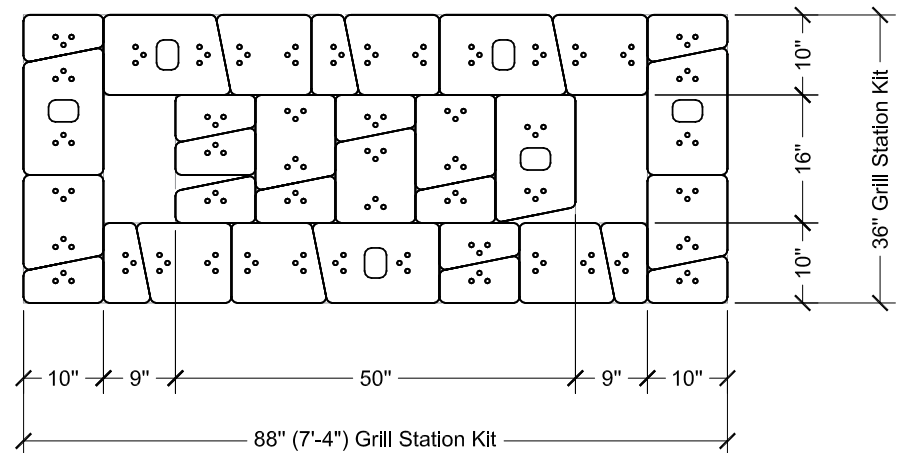

## 3rd Course Isometric

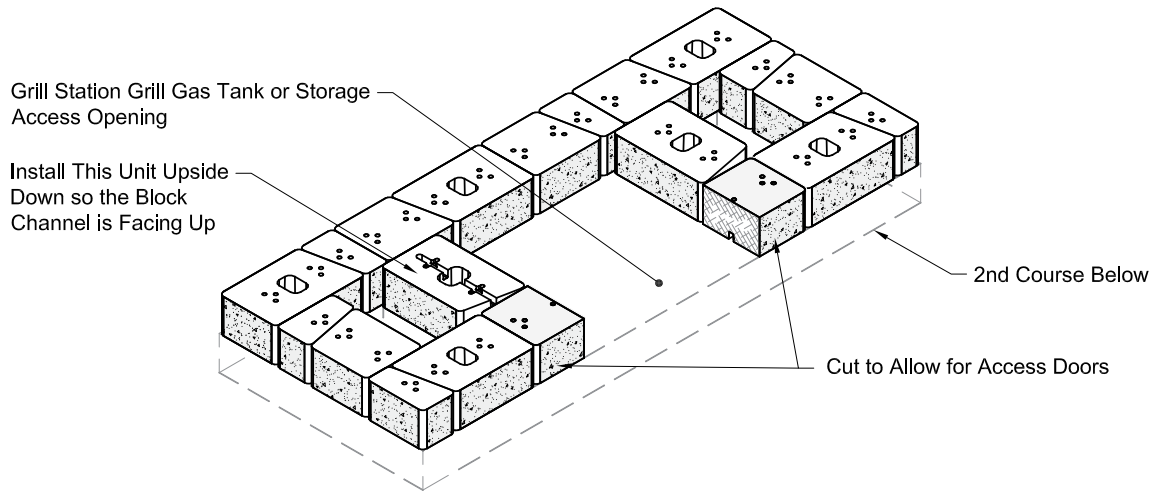

### Block Cutting Note:

Using a concrete saw or wheel grinder tool w/masonry disk, cut block units as needed. Block units to be cut due to obstruction are labeled with solid hatching. Block units to be cut to fit are labeled with angular hatching.

### Block Cutting for Appliances Note:

See appliance manufacturers installation instructions for correct block cutting to allow for proper fit for appliances.

## 3rd Course Plan

Install This Unit Upside Down so the Block Channel is Facing Up

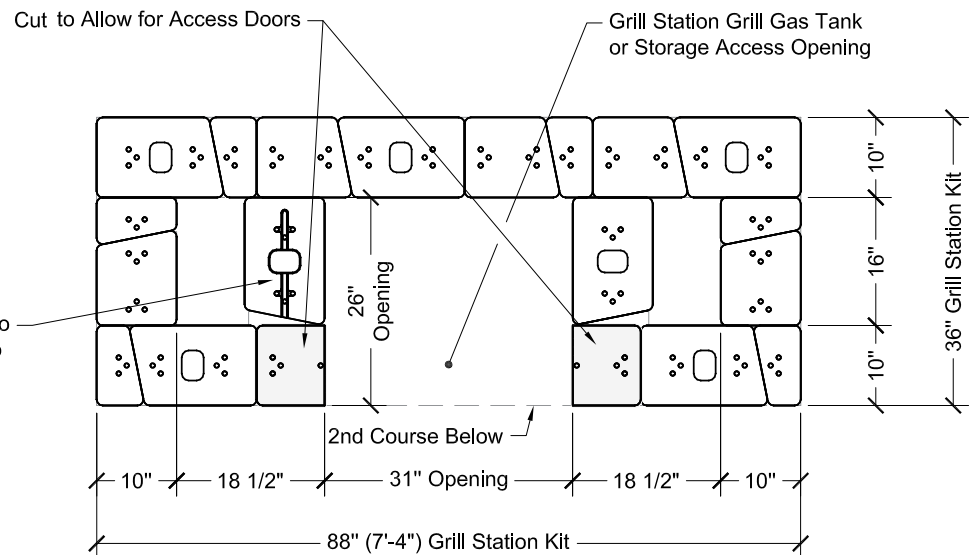

## 4th Course Isometric

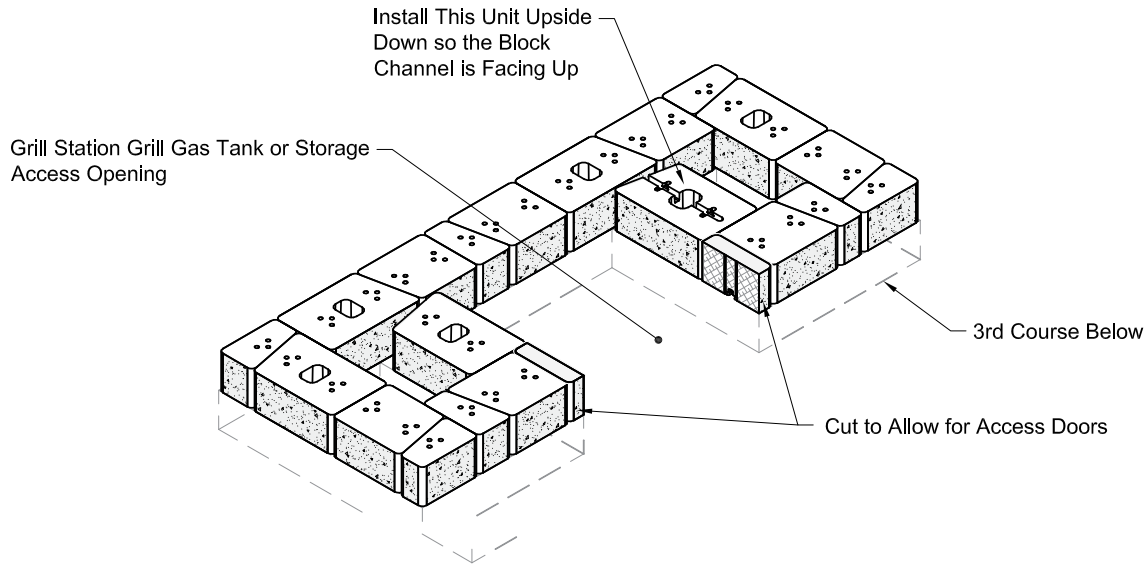

### Block Cutting Note:

Using a concrete saw or wheel grinder tool w/masonry disk, cut block units as needed. Block units to be cut due to obstruction are labeled with solid hatching. Block units to be cut to fit are labeled with angular hatching.

### Block Cutting for Appliances Note:

See appliance manufacturers installation instructions for correct block cutting to allow for proper fit for appliances.

## 4th Course Plan

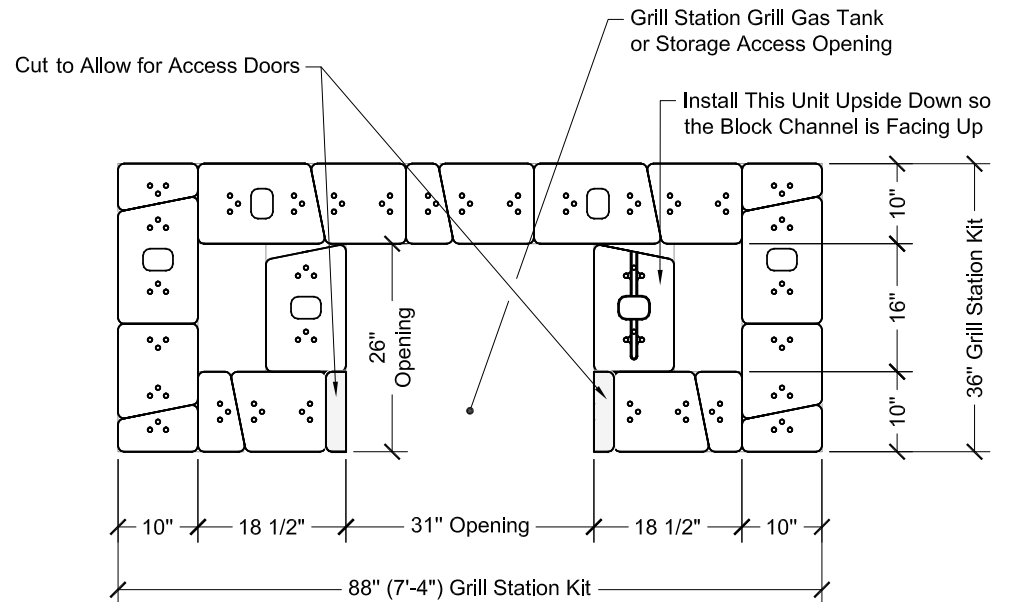

## 5th Course Isometric

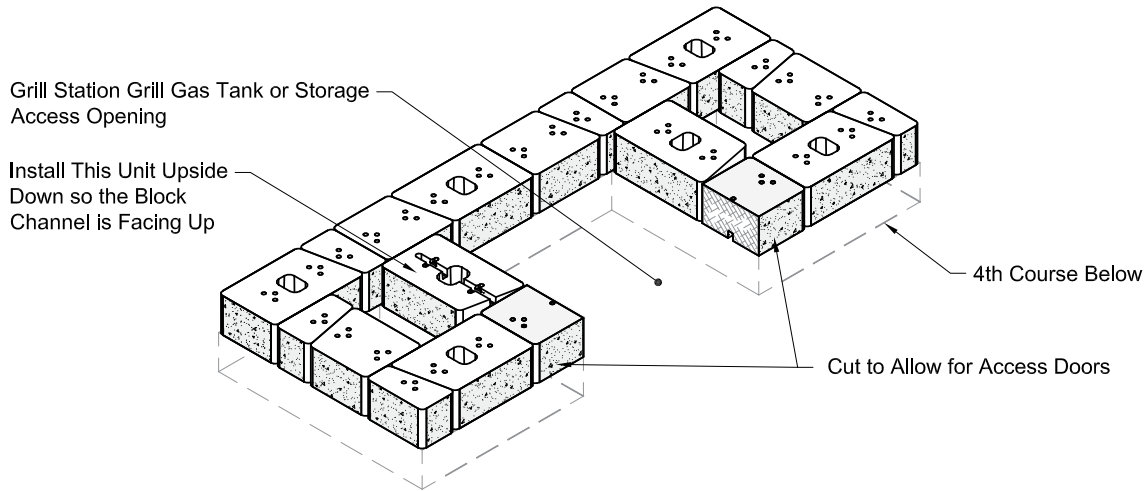

### Block Cutting Note:

Using a concrete saw or wheel grinder tool w/masonry disk, cut block units as needed. Block units to be cut due to obstruction are labeled with solid hatching. Block units to be cut to fit are labeled with angular hatching.

### Block Cutting for Appliances Note:

See appliance manufacturers installation instructions for correct block cutting to allow for proper fit for appliances.

## 5th Course Plan

Install This Unit Upside Down so the Block Channel is Facing Up

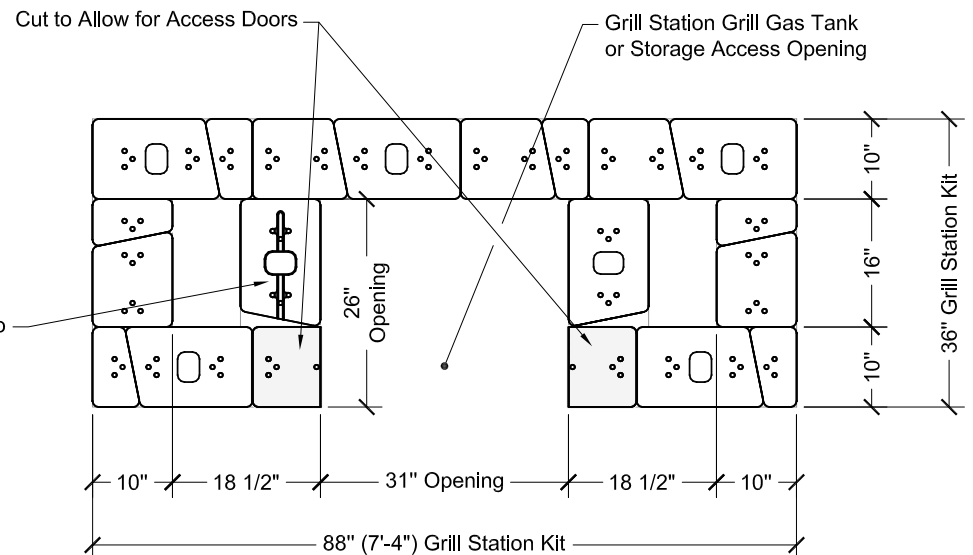

## 6th Course Isometric

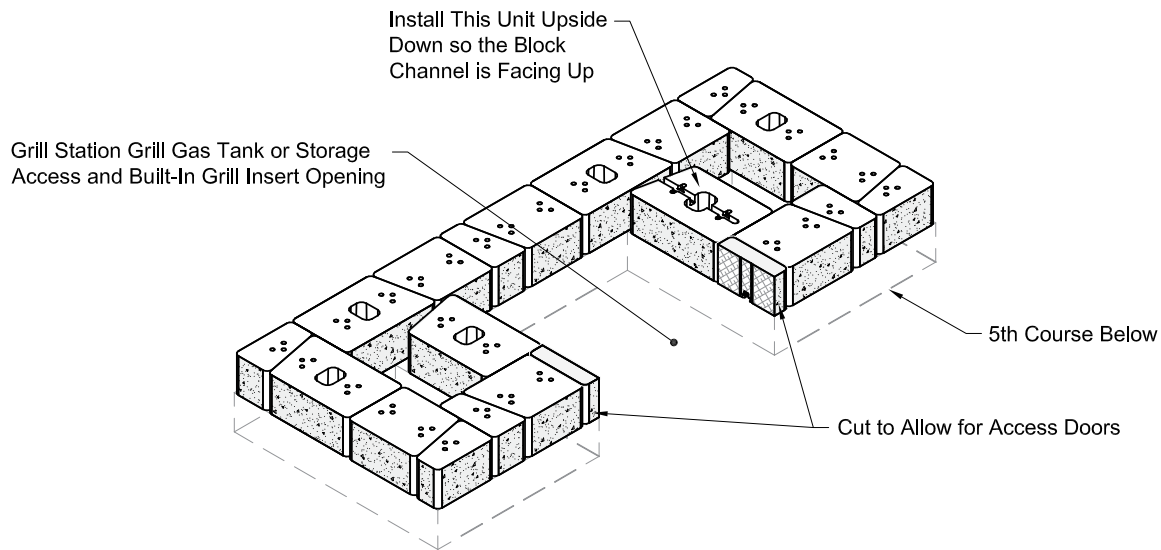

### Block Cutting Note:

Using a concrete saw or wheel grinder tool w/masonry disk, cut block units as needed. Block units to be cut due to obstruction are labeled with solid hatching. Block units to be cut to fit are labeled with angular hatching.

### Block Cutting for Appliances Note:

See appliance manufacturers installation instructions for correct block cutting to allow for proper fit for appliances.

## 6th Course Plan

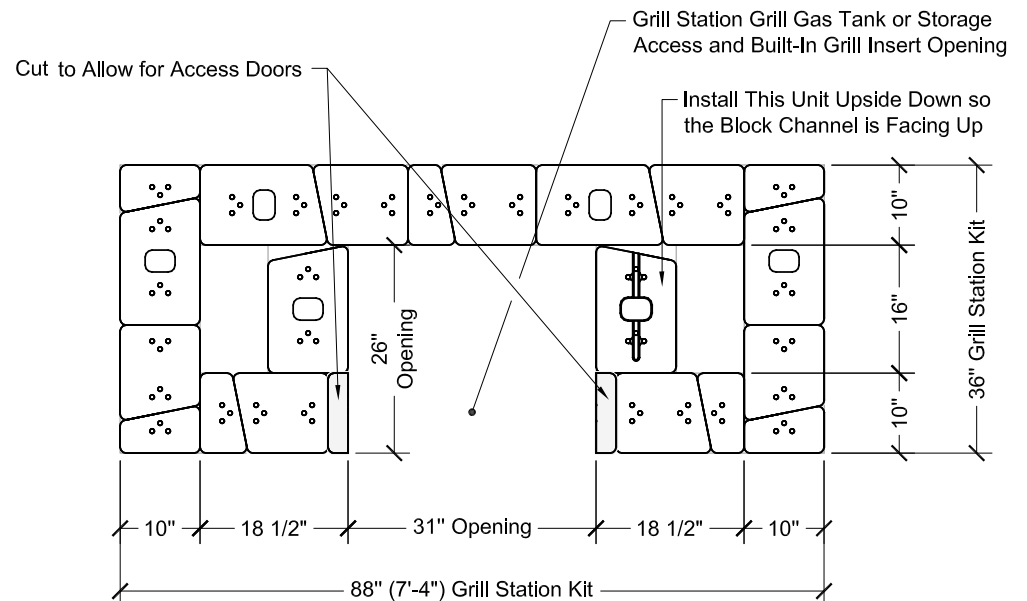

## 7th Course Isometric

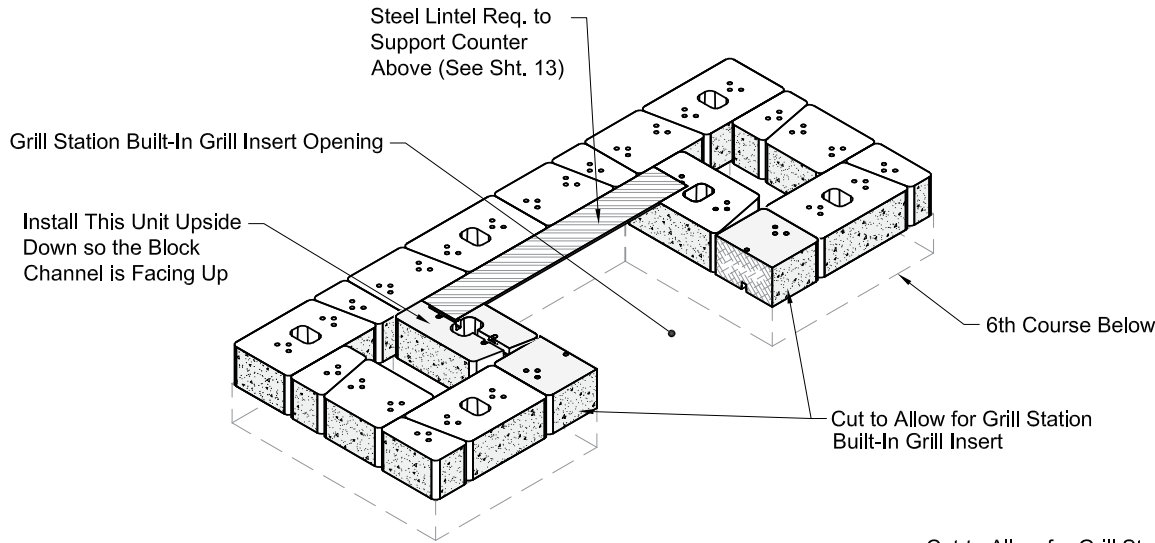

### Block Cutting Note:

Using a concrete saw or wheel grinder tool w/masonry disk, cut block units as needed. Block units to be cut due to obstruction are labeled with solid hatching. Block units to be cut to fit are labeled with angular hatching.

### Block Cutting for Appliances Note:

See appliance manufacturers installation instructions for correct block cutting to allow for proper fit for appliances.

## 7th Course Plan

Install This Unit Upside Down so the Block Channel is Facing Up

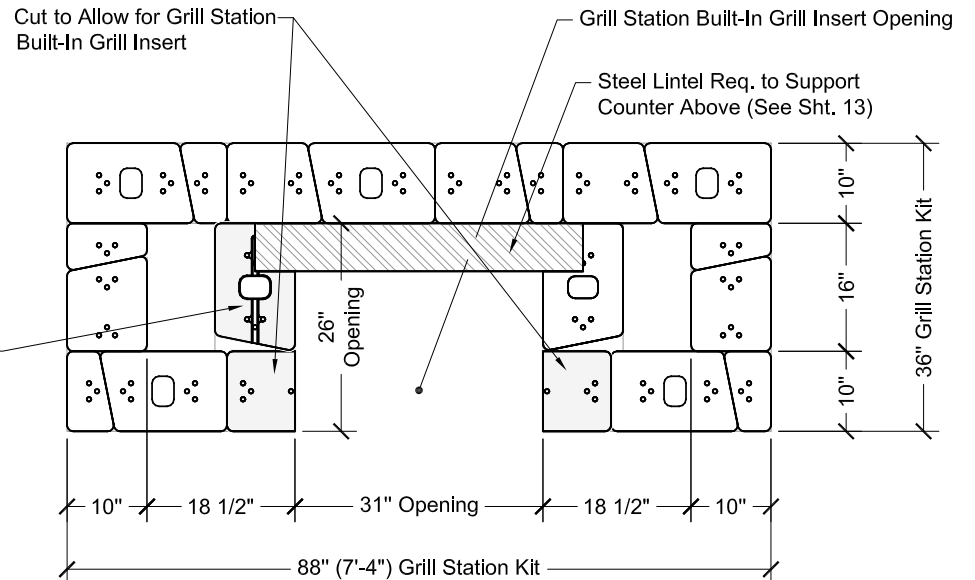

## 7th Course Base Counter Top Support Isometric

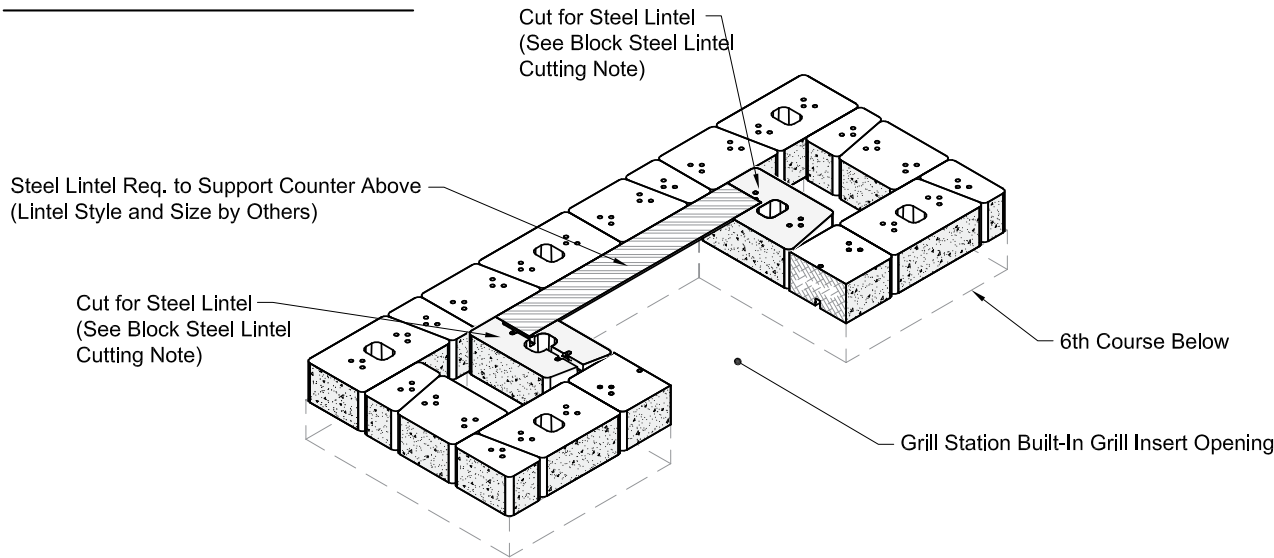

### Block Steel Lintel Cutting Note:

Prior to installing steel lintel, use a wheel grinding tool to notch out top of block creating a level shelf to place steel lintel, such that lintel is flush with top of cut block. Block units to be cut for steel lintel are shown with solid hatching.

## 7th Course Base Counter Top Support Plan

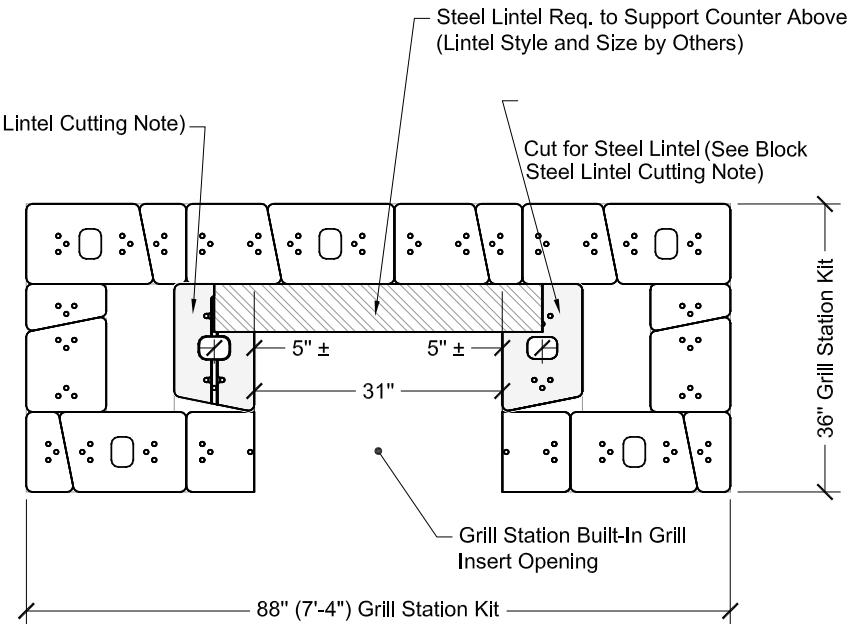

## 7th Course Base Counter Top Isometric

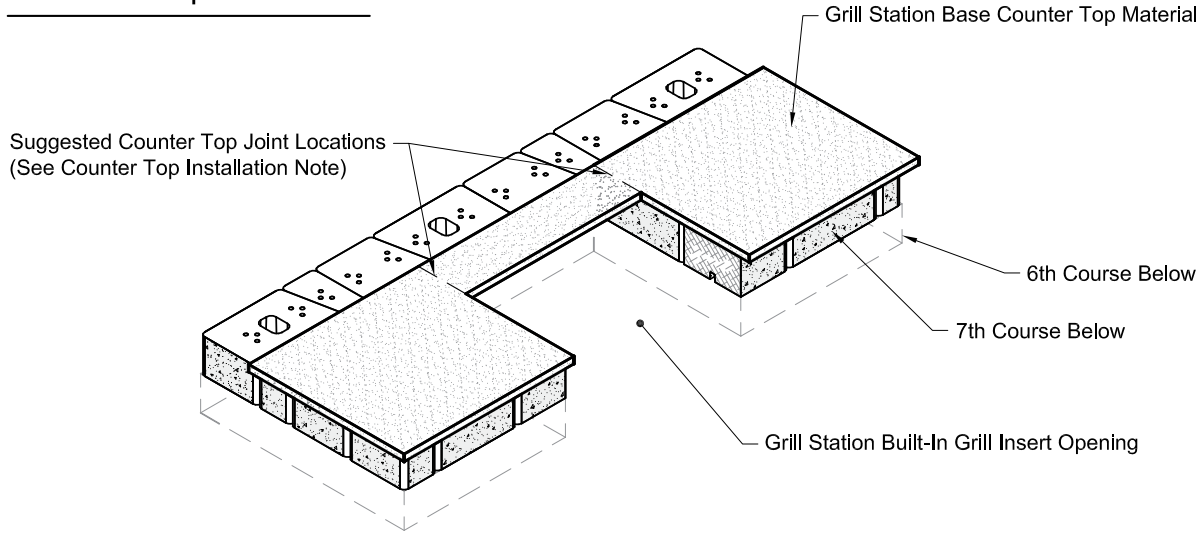

### Counter Top Cutting for Appliances Note:

See appliance manufacturers installation instructions for correct counter top opening sizes. Cut to allow for proper fit for appliances. Unless otherwise directed, use a concrete saw or wheel grinder tool w/masonry disk to cut the counter top as needed.

### Counter Top Installation Note:

Depending on the type of counter top material used the counter top may be installed in multiple pieces as needed. Joints shown with dashed lines are suggested locations only.

Unless otherwise directed install and secure counter top material with adhesive as per manufacturers installation instructions.

## 7th Course Base Counter Top Plan

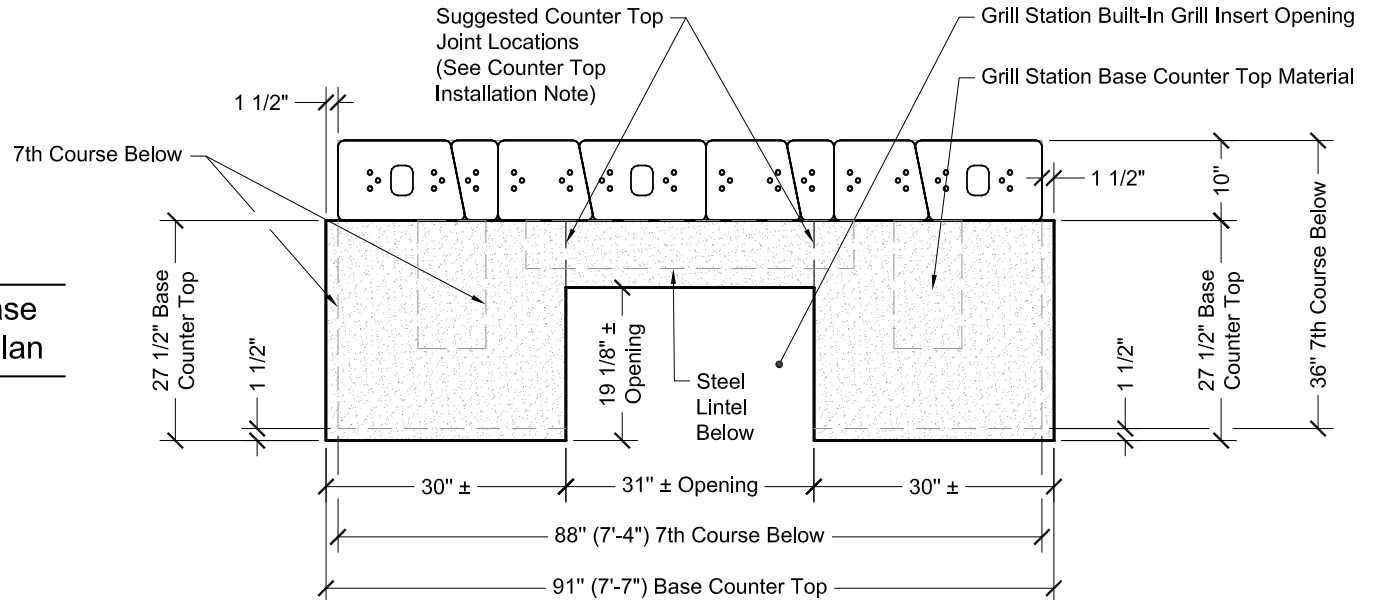

## 8th Course Isometric

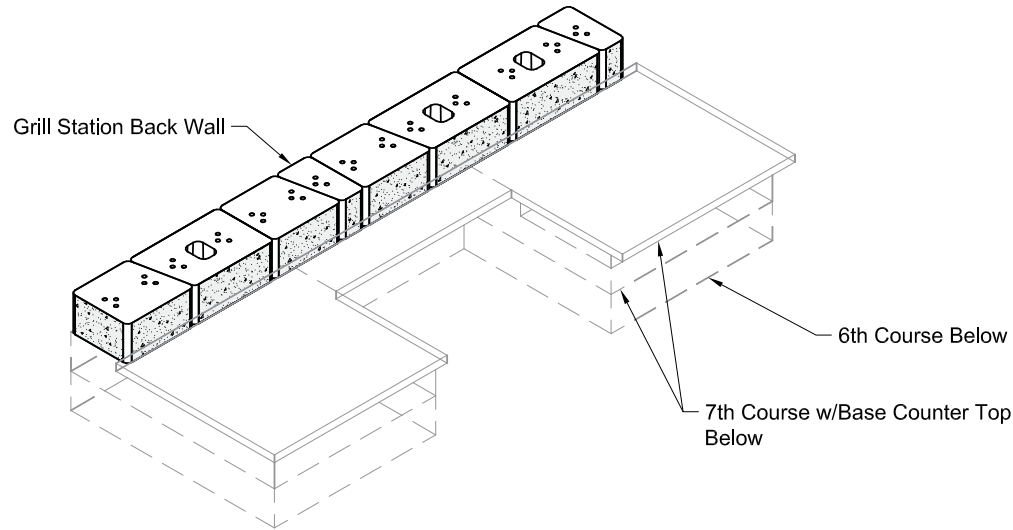

## 8th Course Plan

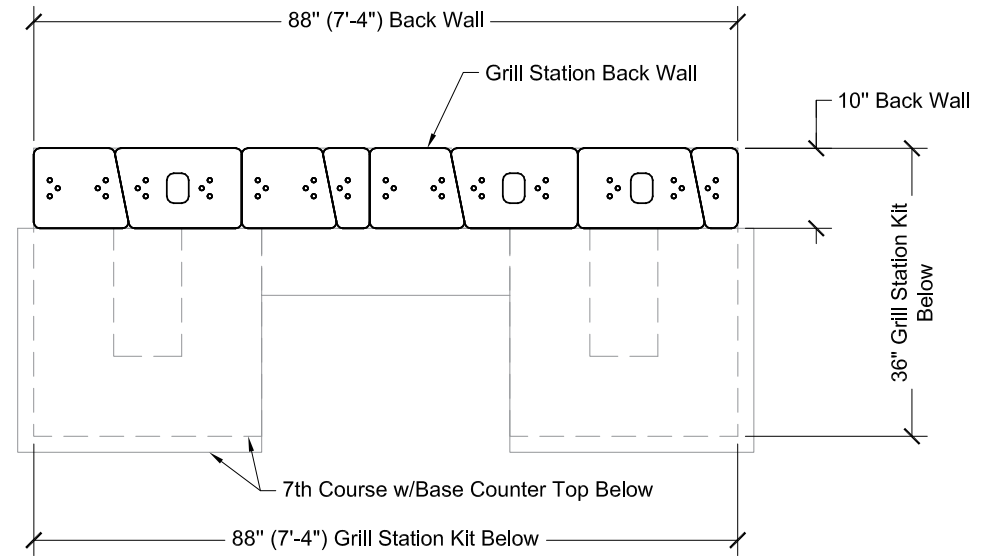

## 8th Course Back Wall Counter Top Isometric

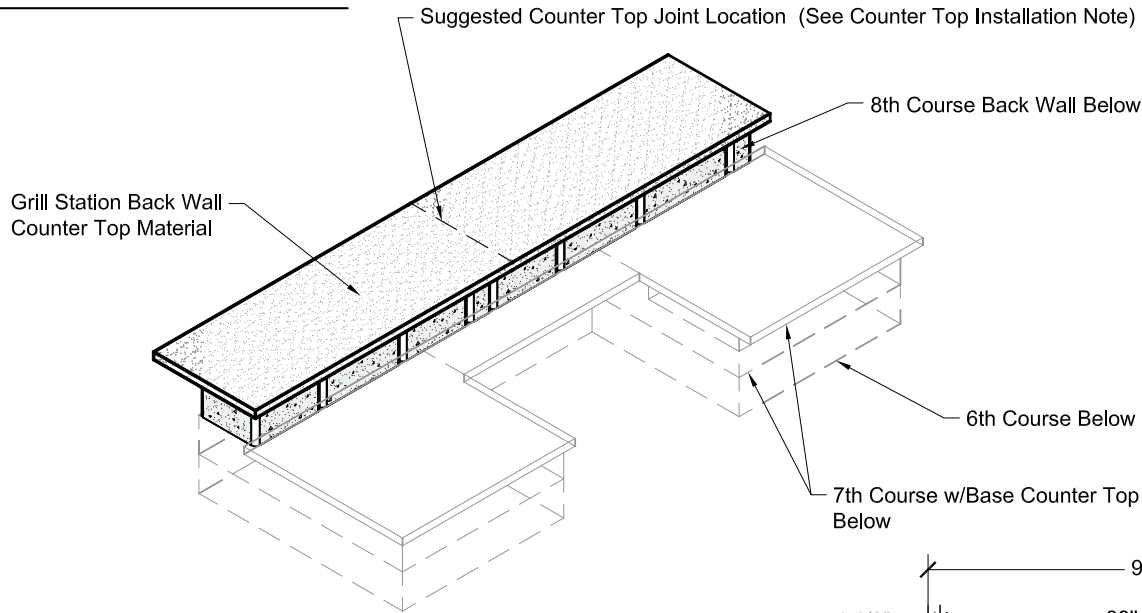

### Counter Top Cutting Note:

Unless otherwise directed, use a concrete saw or wheel grinder tool w/masonry disk to cut the counter top as needed.

### Counter Top Installation Note:

Depending on the type of counter top material used the counter top may be installed in multiple pieces as needed. Joints shown with dashed lines are suggested locations only.

### Counter Top Support Note:

Provide under counter support as needed depending on the over hang of the counter and the type of counter top material used.

Unless otherwise directed install and secure counter top material with exterior grade construction adhesive per manufacturers installation instructions.

## 8th Course Back Wall Counter Top Plan

